

## Features

- The world's smallest and lightest 2000 lumen flashlight
- Utilizes three CREE XM-L LED
- Thermal protection circuit prevents overheating
- Compatible with both 18650 Li-ion and CR123 batteries
- Exceptionally long runtimes using 4×18650 Li-ion or 8×CR123 batteries
- Capable of using 1×18650 or 2×CR123 batteries in emergency situations
- Innovative single button two-stage switch offers versatile functionality (Patented)
- Integrated power indicator light displays remaining battery power (Patented)
- Power indicator secondary function displays battery voltage (accurate to 0.1V)
- Coated mineral glass resists scratches
- Aluminum reflector ensures a smooth and powerful beam
- Stainless steel retaining ring protects the core components from damage
- Constructed from aircraft grade aluminum alloy
- HA III Military grade hard anodized
- IPX-8 standard waterproof (two meters)







## Dimensions

Length: 135mm  
 Head diameter: 60 mm  
 Tube diameter: 50mm  
 Weight: 336g (without battery)

## Accessories

Quality holster, lanyard, spare O-ring

## Output & Runtime

FL 1 STANDARD	TURBO	HIGH	MID	LOW
	<b>2000</b> LUMENS	<b>1100</b> LUMENS	<b>550</b> LUMENS	<b>200</b> LUMENS
	<b>1h15min</b>	<b>3h</b>	<b>7h30min</b>	<b>18h</b>
	<b>283m (Beam Distance)</b>			
	<b>20000cd (Peak Beam Intensity)</b>			
	<b>1.5m (Impact Resistant)</b>			
	<b>IPX-8, 2m (Waterproof AND Submersible)</b>			

### NOTICE

Stated data has been measured according to the international flashlight testing standards ANSI/NEMA FL1 by using eight SYSMAX CR123 batteries in the laboratory. The data may vary due to different battery usage and environment conditions.

## Operation instructions

### Battery installation

Insert 4 × 18650 Li-ion or 8 × CR123 batteries with the positive (+) end pointing toward the flashlight head. In special circumstances, such as an emergency situations, one to three 18650 Li-ion or two to six (R) CR123 batteries may be used. After loading the batteries, the power indicator light will flicker to show the battery voltage. Please refer to the "Power Tips" section of this manual for details.

**Note:** The potential risks of over-discharging batteries can include leakage and explosion so caution must be exercised when using less than 4 x 18650 or 8 x CR123. Ensure you know your batteries' limits and use the TM11's emergency functionality sparingly. Furthermore, maximum output may be reduced when using less than the maximum amount of batteries.

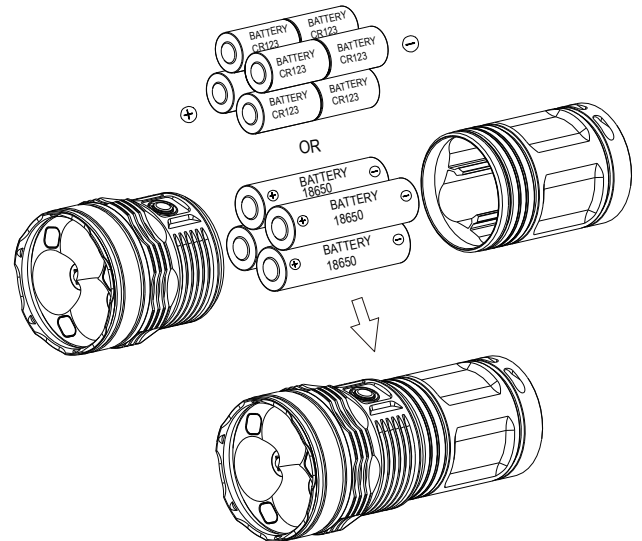

### WARNING

1. Insert batteries with the positive (+) end pointing toward the flashlight head.
2. Do not mix rechargeable and non-rechargeable batteries.
3. Do not mix batteries of different types/brands.
4. Do not mix batteries of different charge levels.
5. Do not use lithium batteries without a protected circuit board.
6. This product does not support 18650 rechargeable Li-ion batteries without protection circuit board as the battery length will be too short to be used.

## General Operation

**NB:** The TM11 utilizes a 2-stage switch (similar to a camera shutter button). The light's numerous functions are selected according to the depth the switch is pressed.

The TM11 has two modes: Daily mode and Turbo mode.

With the light turned off:

- Press the switch partway down and hold to enter Momentary Daily mode. Release the switch to turn the light off again.
- Press the switch all the way down and hold to enter into Momentary Turbo mode. Release the switch to turn the light off again.
- Press the switch partway down and release within one second to access Constant Output Daily mode. Press switch to turn light off again.
- Press the switch all the way down and release within one second to access Constant Turbo mode. Press switch to turn light off again.

## Standby Mode / Lockout and Unlock functions

With the light turned on:

Press the switch all the way down and release within one second to enter into standby mode. In this mode, the light will consume small amounts of power to maintain the settings in the MCU (micro control unit) but appear to be turned off. When in standby mode the power indicator light will flash once every three seconds to show the location of the light.

With the light turned on:

Press the switch all the way down and hold for more than one second. The light will turn off and enter into lockout mode. Lockout mode consumes almost no battery power and prevents the light from accidentally turning on. To exit the lockout mode, simply press the switch three times within one second.

**NB:** When in lockout mode, the power indicator will flash to indicate specific battery voltage. Please refer to the "Power Tips" section of this manual for details.

## Brightness Selection in Daily Mode

When turned on in Daily mode, press the switch partway down to select a brightness level of low, medium or high. The selected brightness level will be memorized when the light is turned off.

## Strobe Function

With the light turned on, press the switch all the way down twice in quick succession to access strobe mode. Press once again to exit the strobe mode.

## Power Tips

1. When the light is on, the power indicator will blink once every two seconds when power levels reach 50%.
2. When the light is on, the power indicator will flicker constantly when power is very low.
3. Each time batteries are inserted or the light is put into lockout mode, the power indicator light will blink in various patterns to show the battery voltage (accurate to  $\pm 0.1V$ ). For example, when the battery voltage is at a maximum charge of 4.2V, the power indicator will blink 4 times in quick succession, followed by a one second pause and two more blinks, indicating a total battery voltage of 4.2V.

## Thermal protection

TM11 is very compact. Extended operation in Turbo mode will cause the body temperature to continually rise, thus, making it too hot to use. So NITECORE does not recommend using the TM11 in Turbo mode for extended periods. TM11 built-in thermal protection circuit prevents overheating. For your safety and to protect the flashlight from failure, the TM11 will automatically reduce its output to prevent overheating once it has reached 60 degrees.

**Precaution:** When the flashlight is hot, do not attempt to cool it by submerging it in liquid.

## Changing batteries

When the power indicator blinks consistently it means the batteries need to be replaced or recharged. Alternatively if the light becomes dim or unresponsive to adjustments once again, the batteries need to be replaced or recharged.

## Maintenance

Clean the threads twice a year with a clean soft cloth and apply thin coat of silicone-based lubricant.

## Warranty Service

NITECORE® flashlights enjoy a worldwide warranty service. Within 14 days of purchase, any defective lights will be offered free replacement (proof of purchase required) by NITECORE® distributors unconditionally. Within 18 months of receipt, NITECORE® offers a free repair service, with the exclusion of damage caused by misuse. As to claims exceeding 18 months, NITECORE® will continue to warrant the product with the cost of parts to be borne by the customer. Customers may contact their local distributor or NITECORE® directly for warranty repair queries. Please note warranty is voided by the following:

1. Damage caused by disassembly or modification without permission
2. Damage caused to the appearance of the product by misuse or accidental occurrence (such as drops or impacts)
3. Damage caused by incorrect battery insertion (reverse polarity) or battery leakage

Details of warranty service, please contact your regional distributor/dealer or send an email to [service@nitecore.com](mailto:service@nitecore.com)

**SYSMAX** Ind. 

SYSMAX INDUSTRY TRADING Co.,LTD

TEL: +86-20-83862000

FAX: +86-20-83882723

E-mail: [info@nitecore.com](mailto:info@nitecore.com)

Web: [www.NITECORE.com](http://www.NITECORE.com)

Address: Rm1407-08, Glorious Tower, 850 East Dongfeng Road, Guangzhou, China 510600

